



Technical Data

Pendant Sets (T2)

Brief product description:

A complete range of high quality robust ceiling accessories, offering durability, reliability and ease of installation.

Lampholder prewired to cable ready to be fitted to ceiling rose.

Features:

- Base moulding produced in clear polycarbonate
- Cover moulding produced in satin finish urea
- Spin-on cover with smooth cable entry
- Base incorporates L, N and Loop-in terminals with 8 individual cable entries and captive screws
- Large capacity Earth terminal with locking terminal screw
- Wiring aperture in base with extra knockout for ease of wiring
- Alternative fixing holes allow for off centre mounting
- 0.75mm² two core circular cable

Product Images



666

Technical Specifications

Standard(s)	BS 67, BS EN 61184, BS6141	
Rating	6 Amp 250V~, 150 Watts Max (566, 569 666, 669, 6612 Products)	
	2 Amp 250V~, 150 Watts Max (720H6 Products)	
Terminal Capacity	4 x 1.0mm ² 3 x 1.5mm ² 1 x 2.5mm ² (566, 569 666, 669, 6612 Products)	
	1 x 0.75mm ² 1 x 1mm ² (720H6 Products)	
Covered by RoHS directive	Yes	
Covered by WEEE directive	No	
Ceiling Rose Size	91mm dia x 30mm (566, 569 Products)	
	85mm dia x 34mm (666, 669, 6612, 720H6 Products)	
Fixing Centres	50.8 mm	
Lampholder Size	38.5mm dia x 58.5mm	
Flex length	153mm (6") (566, 666 Products)	229mm (9") (569, 669 Products)
	305mm (12") (6612 Products)	
	153mm (6") plus 80mm with outer insulation removed (720H6 Products)	

Pendant Sets (T2)

Packaging Information

Cat No.	Description	Packaging Type			Pack Quantity			Barcode		
		Product	Inner Box	Outer Box	Each	Inner Box	Outer Box	Individual	Inner Box	Outer Box
566	6" Pendant		Printed Box	Printed Box	1	10	100	/	5021166566921	5021166566822
569	9" Pendant		Printed Box	Printed Box	1	10	100	/	5021166569823	5021166569922
666	3" 80mm Dia Base		Plain white Box	Plain Brow Box	1	10	100	/	5021166666294	5021166666287
669	3" 80mm Dia Base		B.W Strip Inner	B.W Strip Outer	1	10	100	/	5021166669295	5021166669288
6612	3" 80mm Dia Base		Printed Box	Printed Box	1	10	100	/	5021166661299	5021166661282
720H6	6" Prepared Wire				1	25	250	/		5021166720064

Weights & Dimensions

Cat No.	Description	Dimension (W x L x H) cm			Weight (g)			CMB (m ³)
		Product	Inner Box	Outer Box	Each	Inner Box	Outer Box	Outer Box
566	6" Pendant	8.5 x 8.5 x 21.8	14.5 x 27.8 x 10.5	30.8 x 54.5 x 30	134	894		
569	9" Pendant	8.5 x 8.5 x 21.8	14.5 x 29 x 10.8	31 x 55.6 x 30.8	140	942		
666	3" 80mm Dia Base	8.5 x 8.5 x 22	14 x 17.5 x 6.5	28 x 52.5 x 31	115	874		
669	3" 80mm Dia Base	8.5 x 8.5 x 22.5	12.9 x 28.85 x 11.5	27.3 x 59.8 x 31	132	904		
6612	3" 80mm Dia Base	8.5 x 8.5 x 23	13.2 x 29 x 12	27.8 x 60 x 31.2	138	894		
720H6	6" Prepared Wire			37 x 39.5 x 18.6				

Installation Information

Safety Warning

Before use please read carefully and use in accordance with these safety wiring instructions.

Before commencing any electrical work ensure the supply is **switched off at the mains**. Either by switching off the consumer unit or by removing the appropriate fuse.

Wiring should be in accordance with the latest edition of the IEE regulations (BS 7671).

Wire Identification – Twin & Earth Cable

EARTH = Green/Yellow Slewing

NEUTRAL = Black (pre Apr 04) / Blue (after Apr 04)

LIVE = Red (pre Apr 04) / Brown (after Apr 04)



Technical Helpline: 0845 194 7584
If in doubt consult a competent electrician.

The ends of the individual conductors should have the insulation removed by approx. 10mm. Any bare earth conductors should be sleeved to within 10mm of the ends.

(These details are for general information only and conductor lengths may need to be trimmed in certain installations).

For lighting circuits, use sleeving of the appropriate 'live' colour to ensure clear identification of live connections. See diagram for typical lighting circuit wiring using 4-way junction box.

To prevent fire hazard always use cable of the correct rating and type.

General Installation Instructions

Switch off power supply at consumer unit and remove fuse from circuit.

IF USING THE NEW PRODUCT TO REPLACE AN OLD ONE

1. Release the retaining screws and support the product as you remove it from the wall or ceiling.
2. It is essential that the new product is wired up in the same way as the old one, with Earthing as stated in these instructions.
3. The simplest way is either to label each conductor with the location of the terminal to which it connects as you release it or to transfer one conductor at a time to the corresponding terminal on the new product. (Alternatively refer to the appropriate wiring diagrams for guidance)
4. Before refixing the new product, double check your connections ensuring that no wires are trapped. Do not over tighten the screws.
5. Once you are sure that all work has been completed correctly, replace the fuse for the circuit, switch the power back on, and test.

When Installing From New

1. To assist with the correct installation of this product please consult the appropriate wiring diagram. When connecting the new accessory ensure that only the bare end of the wire enters the terminal, and no bare wires are visible. Always tighten the terminal screws securely.
2. For ceiling roses feed the cable through the aperture in the base, increase entry size if necessary.
 - 2a. Securely screw the base unit to a ceiling joist or wall, as appropriate. Take care to avoid existing wiring or pipe work. When fitted correctly and using 0.75mm 2 core circular cable, the ceiling rose is designed to carry fittings with a maximum weight of 3kg. Install the cables to the appropriate terminals.
 - 2b. To assist with the correct installation of this product please consult the appropriate wiring diagram of two typical installation methods.
 - 2c. Fit the cables around the cable restraints as shown in the illustration on page.
 - 2d. Screw the rose cover back into place.
3. Once you are sure that all work has been completed correctly, replace the fuse for the circuit, switch the power back on, and test. The product is now ready for use.

Pendant Sets (T2)

Installation Information

Ceiling Switch – 1 Way

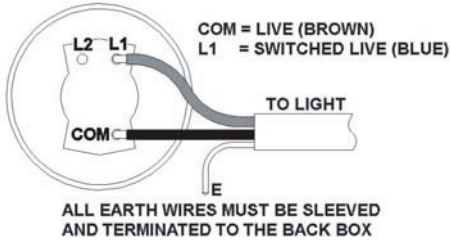

Ceiling Switch – 2 Way

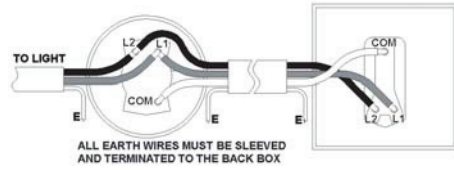

Batten Holders, Ceiling Rose & Pendant Sets

1) Looping Circuit

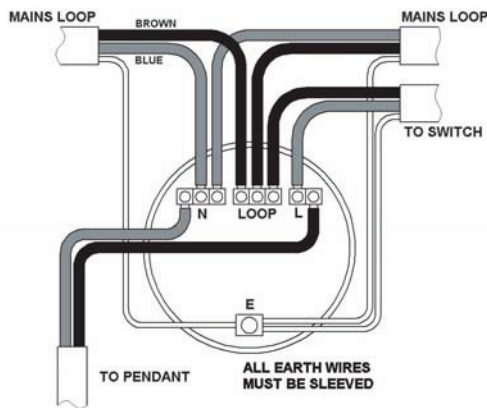

Batten Holders, Ceiling Rose & Pendant Sets

2) Junction Box Circuit

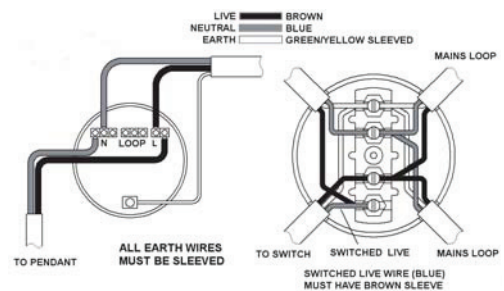

Batten Holders, Ceiling Rose & Pendant Sets (cont)

Cable Restraints

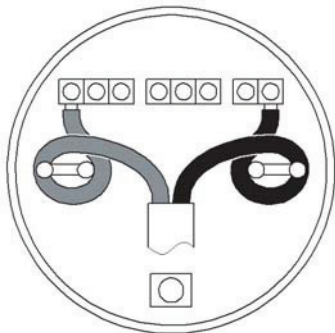

After wiring the ceiling rose & before fitting the cover, ensure both the wires to the pendant fitting are routed around the cable restraint posts as shown in diagram. This must be done to avoid the weight of the pendant & any lamp shade putting undue strain on the terminal connections.

45a Ceiling Switch

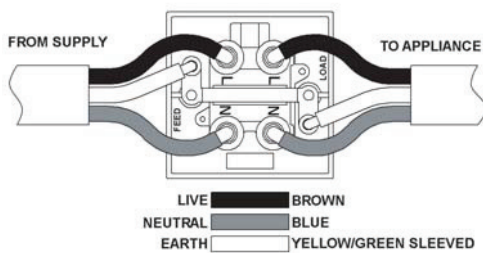

Pendant Lamp Holder

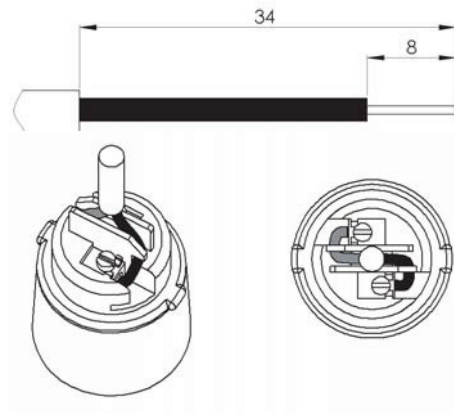

Low Energy Pendant – Shade Fitting

A 40mm shade conversion ring is included with the low energy lamp holder, which can be used to convert an existing 30mm lamp shade.

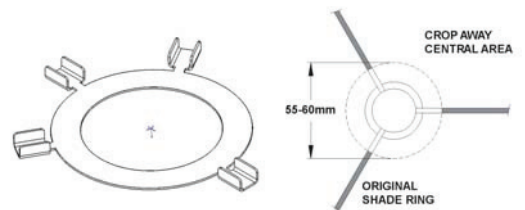

The conversion ring is designed to fit both 2-arm and 3-arm shades.
1) Remove the 30mm shade ring by cutting the support arms close to the central ring, as shown in diagram.

Pendant Sets (T2)

Installation Information

Low Energy Pendant – Shade Fitting (cont)

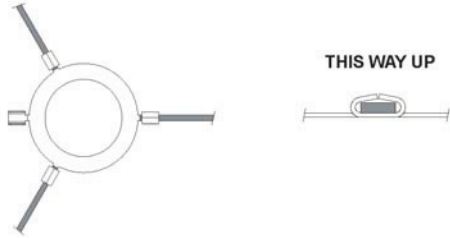

- 2) Fit the ends of the support arms into the appropriate tabs of the conversion ring. Note: it is important to fit the conversion ring under the support arms so that it takes the weight of the lampshade.
- 3) Tighten the metal tab firmly around each support arm using pliers.
- 4) Remove the spare tab if necessary.