

Ei140e Series



230V~ SMOKE & HEAT ALARMS

with Alkaline Battery Backup

Instruction Manual

Read and retain carefully for as long as the product is being used. It contains vital information on the operation and installation of your Alarm. The manual should be regarded as part of the product.

If you are just installing the unit, the manual **MUST** be given to the householder. The manual is to be given to any subsequent user.

Installer Section

Quick Installation Guide

1 LOCATE CORRECT SITING POINT

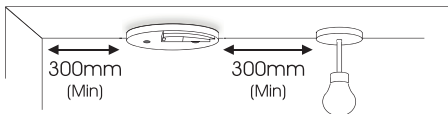

ALARM SHOULD BE CEILING MOUNTED AT LEAST 300mm FROM WALLS & OBSTRUCTIONS, IDEALLY CENTRALLY IN ROOM/AREA

2 FIX & WIRE MOUNTING PLATE

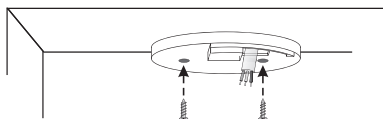

WIRE TO TERMINALS ON THE MOUNTING PLATE AND FIX MOUNTING PLATE TO CEILING USING THE FIXINGS PROVIDED

3 SLIDE ON ALARM

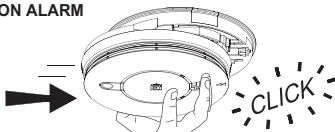

SLIDE ALARM ONTO MOUNTING PLATE. A CLICK SHOULD BE HEARD AS THE TAMPER-PROOF CATCH ENGAGES

4 TEST ALARMS

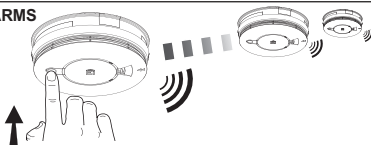

PRESS AND HOLD THE TEST BUTTON ON THE ALARM. THE ALARM AND ANY OTHER INTERCONNECTED UNITS SHOULD SOUND

**ATTENTION: THIS SECTION IS ONLY A GUIDE.
PLEASE READ FULL INSTRUCTIONS BEFORE INSTALLATION**

1. Introduction

The Ei140e series is supplied with an Easi-Fit base that allows very quick and simple installation of the Smoke Alarm, combined with simple detector head removal and replacement. The Easi-Fit base automatically connects both mains power and battery as the detector head slides on to the Easi-Fit base.

Up to 12 Smoke/Heat Alarms can be interconnected so that when one senses fire all the units alarm.

Interconnection can be achieved by hardwire or through an RF mounting plate, the Ei168RC.

All Alarms feature a combined test/hush button.

1.1 Overview

Top View

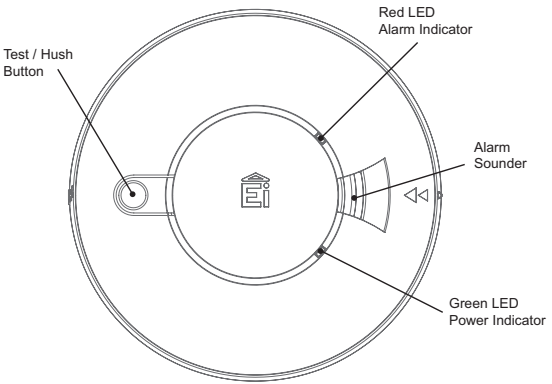

Ei146e Optical Alarm

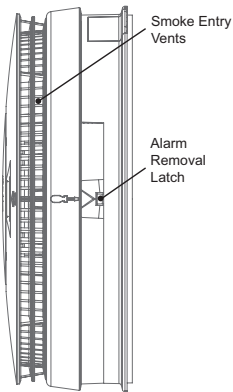

Ei144e Heat Alarm

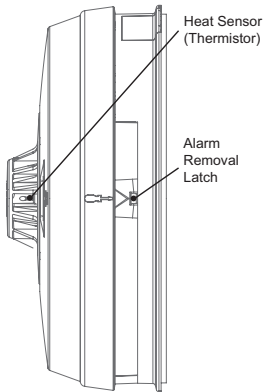

1.2 Technical Specifications

Power Supply	230V AC, 50Hz
Power Consumption	0.25W (standby)
Max Current Draw	60mA
Battery Backup	9V Replaceable Alkaline battery
Alarm Sounder	Piezoelectric Horn
Alarm Sound Level	85dB(A) at 3 meters (min)
Test/Hush Button	Checks sensors, electronics, interconnection (when applicable) and sounder. If the unit is in alarm when pressed, it silences the alarm for 10min
Visual indicators	Green LED – Power supply Red LED – Self-test, alarm (if coincides with horn sounding), hush mode, memory or fault
Operational Life	10 years
Interconnection	Up to 12 units can be interconnected via a hardwired or wireless system (using optional Ei168RC mounting plate)
Fixings	Supplied with Easi-fit anti-tamper mounting plate with integral terminal block and wiring cover, includes screws and wall plugs
Operating & Storage Temperature	-10°C to +40°C*
Humidity Range	15% to 95% RH (non-condensing)
Plastic Material	HIPS (UL94V-0 flame retardant rated)
Dimensions	Ei146e: Product - Ø148mm x 50mm Package - 155mm x 155mm x 62mm Ei144e: Product: - Ø148mm x 61mm Package:
Weight	350g (including packaging)
Warranty	5 years (limited)
Approvals	KM522831, KM83678, EN14604:2005+AC 2008, BS5446-2:2003

* Temperature and Humidity conditions are for normal operation and storage. The Alarms will function outside these ranges as required by the specific product standards. Extended exposure to conditions outside these ranges can reduce product life. For advice on prolonged operation outside these range consult the manufacturer.

2. Installation

2.1 Important Safety Instructions

WARNING: Mains operated Alarms must be installed and interconnected by a qualified electrician in accordance with the local appropriate Regulations for Electrical Installations. Failure to install this Alarm correctly may expose the user to shock or fire hazards and damage the product.

The Alarm is designed to be permanently mounted, using its own built-in terminal block to connect it to the mains. The mounting plate can be screwed directly to the ceiling. Alternatively, it can be screwed to a standard junction box (BS 4662 single gang accessory box). The Alarm must not be exposed to dripping or splashing.

There are important markings on the underside of the Alarm.

WARNING: An all-pole mains switch shall be incorporated in the electrical installation of the building.

WARNING: Batteries (battery pack or batteries installed) shall not be exposed to excessive heat such as sunshine, fire or the like.

ATTENTION: Alternative Energy Sources - (Wind, Solar, UPS etc.)

This product is designed to be connected to a Pure or True Sine Wave 230V AC supply.

If connecting to a power source that utilises an inverter, e.g. PV solar panel, the Total Harmonic Distortion (THD) must be less than 5%. If in doubt, please check with the manufacturer of the inverter. This also applies to battery powered UPS (Uninterruptible Power Supply) inverters.

ATTENTION: Light Dimmer Circuits – The Alarms must not be powered from a light dimmer circuit.

ATTENTION: Do not install Alarms in new or renovated buildings until all work is completed.

ATTENTION: The Alarm must **not** be connected when the house wiring insulation is being checked with high voltages. i.e. Do **not** use a high voltage insulation tester on the Alarm.

ATTENTION: The Alarm must be continuously powered 24 hours a day so it is important that it is not on a circuit that can be turned off by a switch.

ATTENTION: (UK) BS 5839-6:2019 gives the following recommendations regarding the mains supply to be used in a Grade D system. The power supply for the Alarms should be derived from the public electricity supply to the dwelling. The mains supply to the Alarms should take the form of either:

- (a) an independent circuit at the dwelling's main distribution board, in which case no other electrical equipment

- should be connected to this circuit (other than the supply to a dedicated social alarm control unit); or
- (b) a separately electrically protected, regularly used local lighting circuit.
- (See BS 5839-6:2019 for further information).

2.2 Where to Locate the Alarm?

The advice here follows the guidance in British Standard BS 5839-6:2019 in general (for further information refer to the standard).

The main reason for fitting Smoke/Heat Alarms in dwellings is to ensure that when there is a fire, sufficient early warning is given so that everybody can escape safely. This means that the Smoke/Heat Alarms should ideally be located near all potential sources of fires and that the alarm should be heard throughout the house – particularly in the bedrooms.

It is also important that nuisance/false alarms are minimised to ensure the Alarms are not disabled or ignored.

A single Smoke Alarm will give some protection if it is properly installed, but most homes will require two or more to ensure that a reliable early warning is given. For recommended protection you should put individual Smoke Alarms in all rooms where fire is most likely to break out (apart from the kitchen and bathroom).

BS 5839-6:2019 gives guidance on:

- how many Alarms to install
- what type of Alarm to use
- where to position Alarms

The above points will depend on the type of dwelling to be protected and the level of fire risk.

Fire Risk Assessment

The 'Grade' and 'Category' of system that should be installed depends on the fire risk. It is therefore recommended that a Fire Risk Assessment is undertaken. The Risk Assessment would be based on a combination of probabilities:

- fire occurring
- injury or death to occupant
- system operating correctly with a fire
- early detection and warning to occupants in the event of a fire

The greater the risks, the more comprehensive and reliable systems needs to be.

LD (Life protection in Dwellings) Systems define the level of fire protection required for households, depending on the fire risk and regulations. Aico/Ei Electronics recommends that an LD1 system be installed for optimum protection.

UK Requirements (BS 5839-6:2019)

LD1 OPTIMUM PROTECTION



for dwellings where occupants may be at high risk (e.g. elderly)

Optimum Protection LD1: As LD2, but in addition Smoke or Heat Alarms should be located in all rooms and other areas of the dwelling.
(apart from toilets or bathroom)
Interconnect all Alarms

LD2 BASIC PROTECTION

for new or materially altered dwellings or existing dwellings with poor structural fire precautions

Basic Protection LD2: Smoke or Heat Alarms in all rooms or areas that present a high fire risk to occupants.
(apart from toilets or bathroom)
Interconnect all Alarms



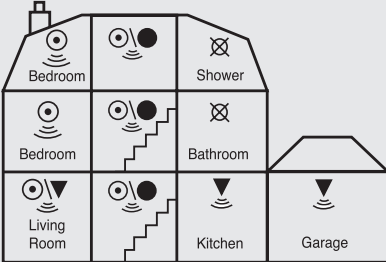

- 
Multi-Sensor or Smoke Alarms located:
 - on each storey
 - every 7.5 m of hallways and escape routes
 - within 3m of all bedroom doors
(apart from toilets & bathrooms ☒)
- 
Heat Alarms located in:
 - each Kitchen
(Heat Alarms must be within 5.3m of potential fire sources)
- 
Multi-Sensor or Heat Alarms located in:
 - each Living room (i.e. most frequently used daytime room)

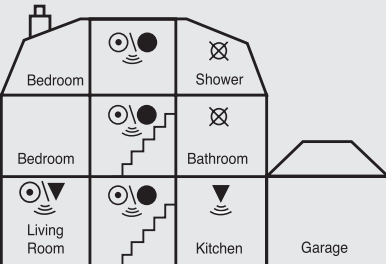

Multi Storey Dwelling LD1



Multi Storey Dwelling LD2

-  Multi-Sensor Fire Alarm
-  Optical Smoke Alarm
-  Heat Alarm
-  do not fit Alarm

2.3 Which Alarm in what Room?

Selecting Alarm Type

Location	Ei146e Optical Smoke Alarm	Ei144e Heat Alarm (i)
Hall, Corridors, Escape routes	✓	✗
Kitchens / Garages	✗	✓ (iii)
Living Rooms	✓	✓ (ii)
Bedrooms	✓	✗
Shower / Bathrooms	✗	✗

- (i) A Heat Alarm should only be used in a room adjoining an escape route, in conjunction with Multi-Sensor Fire Alarms or Smoke Alarms on the escape routes. All the Alarms should be interconnected to ensure the early warning will be heard.
- (ii) Some Fire authorities (concerned with the slow response of Heat Alarms) advise that Multi-Sensor Fire Alarms or Smoke Alarms should be fitted in living rooms. This is acceptable according to BS 5839-6:2019 provided there are clearly not going to be problems with nuisance alarms. Fit Heat Alarms only if nuisance alarms are very likely and it is acceptable that a warning will only be given by the Heat Alarm when there is a very significant flaming fire in the room. If the door(s) and windows are not closed to contain the fire and heat, it is extremely unlikely that the Heat Alarm would respond before a Multi-Sensor Fire Alarm or Smoke Alarm sited outside in the corridor.
- (iii) In enclosed kitchens with doors closed.

Improved Audibility

The effectiveness of a Category LD2 system can be significantly enhanced if an additional Alarm (interconnected) is installed in the master bedroom. This will help ensure that a responsible person will quickly be alerted to a fire and can arrange for an orderly evacuation of children and other vulnerable occupants.

Grade D System

The mains powered Smoke and Heat Alarms with battery back-up, covered by these instructions are suitable for the requirements for a Grade D System.

A Grade D system is needed for:

- New or materially altered dwellings up to three-storeys, with no floor over 200m² in area.
- Existing dwellings with poor structural fire precautions, up to three storeys, with no floor over 200m² in area.
- Houses in Multiple Occupation (HMOs) of one or two-storeys, with no floor over 200m² in area.
- Individual dwellings units of two or more rooms in HMOs.

Check that a Grade D system is adequate for the dwelling into which the system is being installed.

2.4 Where in the Room?

The locations must comply with applicable building regulations.

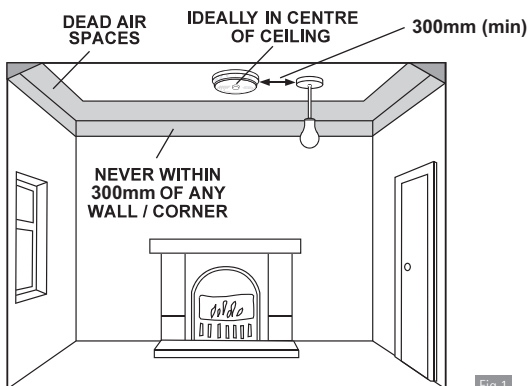

Fig.1

Ceiling Mounting

Hot smoke rises and spreads out, so a central ceiling position is the preferred location. The air is “dead” and does not move in corners, therefore Alarms must be mounted away from corners. Fit the Alarm:

- At least 300mm away from walls. (see Figure 1).
- At least 300mm from any light fitting or decorative object which might obstruct smoke / heat entering the Alarm.

Wall mounting (Ei146e only)

If ceiling mounting is impractical, **only** the Ei146e Optical Smoke Alarm may be mounted on a wall, provided that:

- the top of the detection element is between 150mm and 300mm below the ceiling (see Figure 2);
- the bottom of the detection element is above the level of any door openings;

Wall mounting should only be considered where close spaced beams or similar obstructions may preclude ceiling mounting. It is considered to be the responsibility of the installer/client to determine if the presence of asbestos in the ceiling material would make ceiling mounting 'impractical'.

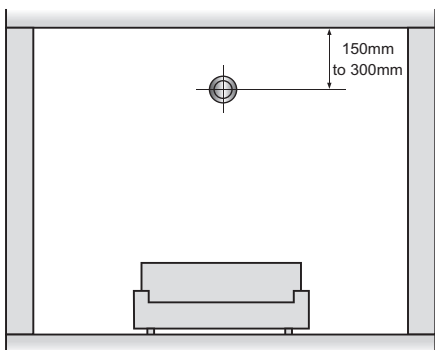

Fig.2

Sloping Ceiling

With a sloping or peaked ceiling install a Smoke Alarm within 600mm of the peak (measured vertically) and a Heat Alarm within 150mm.

If the height of the peak is less than 600mm in the case of Smoke Alarms or 150mm in the case of Heat Alarms, it is regarded as being flat. (see Figure 3).

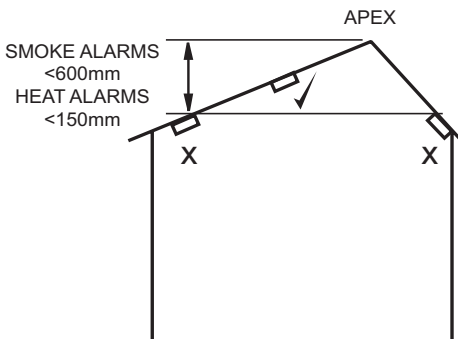

Fig.3

2.5 Locations To Avoid

DON'T place Smoke or Heat Alarms in any of the following areas:

- Bathrooms, shower rooms or other rooms where the Alarm may be triggered by steam, condensation.
- Places where the normal temperature can exceed 40°C or be below -10°C (e.g. furnace rooms, directly above ovens or kettles etc.) as the heat/steam could cause nuisance alarms.
- Near a decorative object, door, light fitting, window moulding etc., that may prevent heat or smoke from entering the Alarm.
- Surfaces that are normally warmer or colder than the rest of the room (e.g. attic hatches).
Temperature differences might stop heat or smoke from reaching the Alarm.
- Next to or directly above heaters or air conditioning vents, windows, wall vents etc. where air draughts can change the direction of airflow and cause rapid temperature fluctuations.
- In very high or awkward areas (e.g. over stairwells) where it may be difficult to reach the Alarm (for testing, hushing etc.).
- In or near very dusty or dirty areas as dust build-up on the optical smoke sensor can impair performance. It can block the insect screen mesh and prevent smoke from entering the sensor. Dust build up can also increase the response time of the heat sensor.
- Locate the Alarm at least 1m from dimmer controlled lights and wiring as some dimmers can cause interference.
- Locate the Alarm at least 1.5m and route wiring at least 1m away from fluorescent light fittings as electrical “noise” and/or flickering may affect the Alarm. Do not wire into the same circuit as fluorescent lights or dimmers.
- In insect infested areas. Small insects getting into the optical smoke sensor can cause intermittent false alarms. Insects and contamination on the heat sensor can increase its response time.
- In a damp or humid area.

Do not locate **Heat Alarms** directly above a sink or cooker – Keep at least 1 m horizontal distance between these items and the Alarm.

2.6 Mounting and Wiring

Disconnect the AC mains supply from the circuit that is going to be used.

WARNING: to prevent injury, this apparatus must be securely attached to the ceiling or wall in accordance with the installation instructions.

1. Select a location complying with the advice in the previous sections.
2. Place the mounting plate exactly where you want to mount the Alarm. With a pencil mark the location of the two screw holes. Taking care to avoid any electrical wiring in the ceiling/wall, drill holes using a 5.0mm drill bit through the centre of the marked locations. Push the plastic screw anchors provided into the drilled holes.
3. Lift off the wiring cover using a flat head screwdriver as shown in Figure 4.

The house wiring must be connected to the terminal block on the mounting plate as follows:

L: Live - connect to the house wires coloured brown or marked L.

N: Neutral - connect to the house wires coloured blue or marked N.

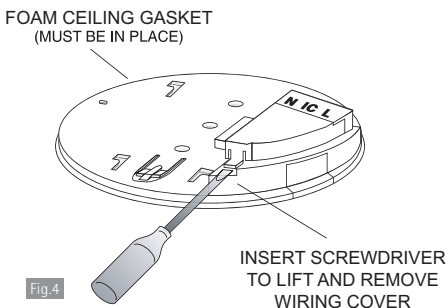

WARNING: Wiring must be installed in compliance with local regulations.

WARNING: Mixing (or poorly terminating) the Live and Neutral connections when interconnecting Alarms may damage all the Alarms - ensure that the same colour wires are used throughout the premises for Live, Neutral and Interconnect wires.

We strongly recommend that you check for the following before connecting the Alarm:

- check for Live and Neutral using a two probe tester.
- check for Live using a neon tester.
- check that the Interconnect wire is NOT connected to Live, Neutral or Earth. **Do not use an Earth wire for the Interconnect line.**

Note: The Alarm does not need to be earthed. However the terminal marked \oplus is provided for the convenience of the installer so that any copper Earth wire or cable coloured green and yellow, can be safely terminated.

To interconnect Alarms connect all the IC terminals together as shown in Figure 7 (see section 2.7 - **Interconnecting Alarms**).

4. If the mains wires are recessed, bring the wires through the rear hole in the mounting plate as shown in Figure 5.

If the mains wires are being brought along the surface:

- (a) position the mounting plate so the cable trunking is as shown in Figure 5.
- (b) the mounting plate has a removable section, take it out to interface directly with 25mm conduit as shown in Figure 6. If interfacing to 16mm conduit carefully cut around the marked section, leaving the top intact and replace the section. (If you are not using surface wiring, the removable section must be left in place for electrical safety reasons).

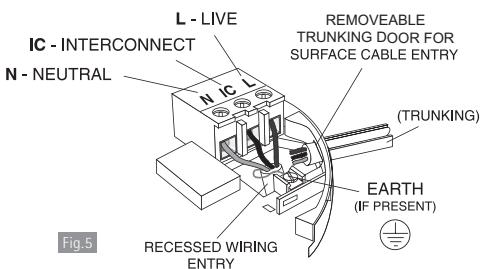

Fig.5

There are two other positions which are also suitable for the surface wiring to enter (and exit) the alarm, one next to the removable section and another directly opposite.

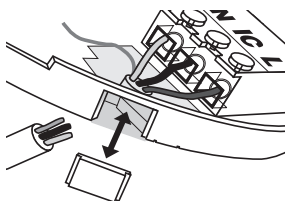

Fig.6

5. Carefully align the mounting plate and screw into place. Connect the wires to the terminal block. With recessed wiring, ensure the rear gasket seals around the edge of the hole in the ceiling or wall. This is to prevent air draughts affecting the smoke/heat entering the Alarm. If the hole is too large or the Alarm does not seal it, it should be sealed with silicone rubber or equivalent.

6. Replace the wiring cover.
7. Attach the battery to the battery snaps. Carefully line up the Alarm on the mounting plate and slide on.
8. Press and hold the test/hush button for 10 seconds. The horn will sound. On release of the test button the local alarm will stop sounding immediately and the interconnected Alarms will stop sounding a few seconds later.
9. Connect the mains power to the Alarm circuit. Check the green light is on.
10. Attach the 'fuse board label' provided on or near the distribution board and write in date installed and the number of Alarms on the circuit.
11. Ensure the Alarm operates correctly – see section 3 - **Maintaining your Alarm.**

2.7 Interconnecting Alarms

With interconnected Alarms, when one device detects fire, all will sound. All Alarms will sound but only Alarms detecting the emergency event will be flashing their red LED alarm indicator.

Heat Alarms must **always be interconnected** to Smoke Alarms to ensure early warning. They are not suitable as a fire safety device unless they are part of a fire safety system i.e. when interconnected to one or more Smoke Alarms.

Note: A maximum of 12 Alarms and accessory devices can be interconnected in an Aico/Ei Electronics Alarm system. If you wish to connect more than 12 Alarms, contact the Aico Technical Department on 01691 664100.

WARNING: Do not hardwire interconnect mains powered Alarms with low voltage or battery powered Aico/Ei Electronics Alarms/devices or any other type of Alarm produced by another manufacturer. Doing so may damage the Alarms and could result in a shock or fire hazard.

Systems using more than 3 or 4 Alarms must be very carefully planned to ensure nuisance/false alarms are not excessive. e.g. from cooking fumes or steam. The following is suggested:

An Alarm Control Switch (model Ei1529RC) or a Fire/CO Alarm Controller (model Ei450) should be incorporated into the system and be readily accessible to all occupants so that the source of an alarm can be quickly identified.

Make electrical connections as shown in Figure 7.

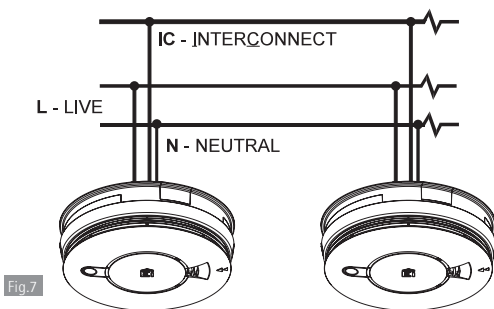

In the UK it is recommended that the following coloured cores are used (for example with triple flat 6243Y cable).

<i>230V supply</i>	<i>Brown</i>
<i>Neutral</i>	<i>Grey - sleeved blue at terminations</i>
<i>Interconnect</i>	<i>Black</i>

The interconnect wire (minimum 0.75mm² cable) must be treated as if it was Live. It should be insulated and sheathed.

A maximum of 250 metres of wire can be used (maximum resistance between detectors 50 Ohms).

These Smoke/Heat Alarms should be interconnected only within the confines of a single family living unit. If they are connected between different units there may be excessive nuisance/false alarms. Everybody may not be aware that they are being tested or that it is a nuisance/false alarm caused by cooking etc.

The Alarm can also be RF interconnected to other RF Alarms and devices by fitting an Ei168RC mounting plate. The Ei168RC will enable the Ei140e series Alarms to communicate RF messages to other Ei Electronics products such as the Ei450 RadioLINK Alarm Controller where you can remotely locate, test and hush your Ei140e Series Alarms using this wireless controller.

For detailed user instructions on using the Ei168RC with the Ei140e series, please consult the Ei168RC instruction manual.

2.8 Removing the Alarm

WARNING: Disconnect mains before removal

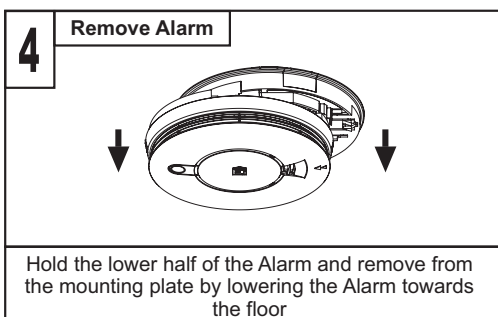
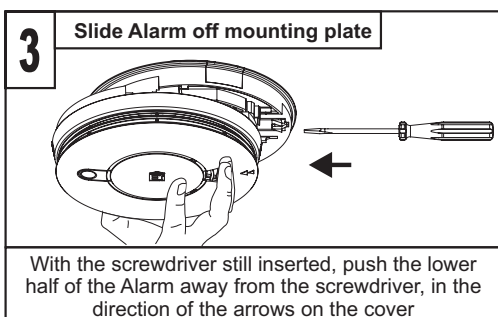
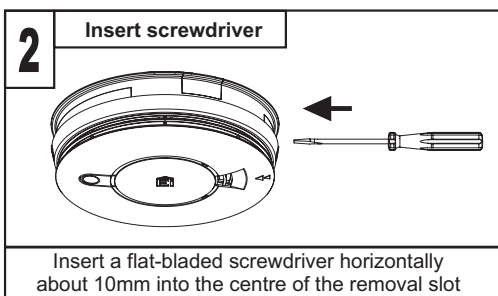
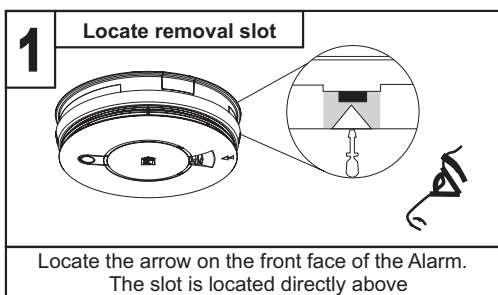

User Section

3. Maintaining your Alarm

3.1 Testing your Alarm

Frequent testing of all your Alarms is a requirement to ensure they are functioning correctly. Guidelines and best practices for testing are as follows:

1. After the system is installed.
2. Once monthly thereafter.
3. After prolonged absence from the dwelling (e.g. after holiday period).
4. After repair or servicing of any of the systems elements or household electrical works.

Inspecting and Testing procedure

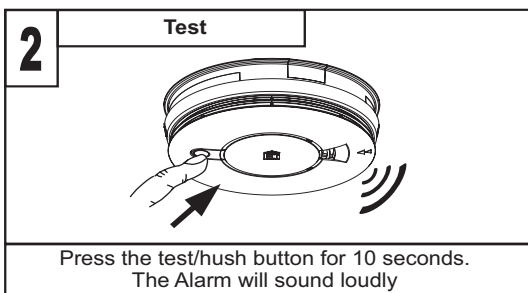
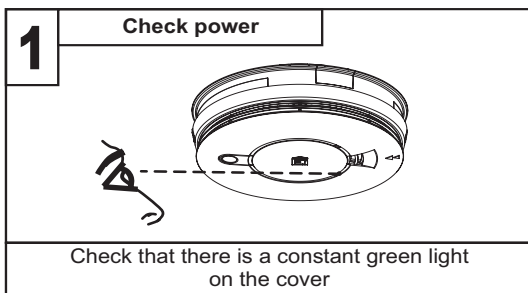

- (i) Check that the **green LED power indicator** is on continuously. (If it is off, check circuit breakers, fuses and wiring etc.)
- (ii) Check that the red LED on the cover flashes once every 40 seconds to indicate normal operation – If the memory has been set indicating that the Alarm has been activated in the last 24 hours, the red LED will flash twice every 40 seconds. After 24 hours, the memory will be cleared or if the Test button is pressed.
- (iii) Check also that there are no faults i.e. NO chirps (if this is the case please see indicator summary table).

- (iv) Check for any sign of contamination such as cobwebs or dust and clean the Alarm as described in the “cleaning” section if necessary.
- (v) Press the test button for up to 10 seconds to ensure the sensor chamber, electronics and sounder are working. A red light on the cover will flash while horn is sounding. The alarm will stop when the button is released. Pressing the test button is the best way to ensure the Alarm is operating correctly. This action will also clear the memory.
- (vi) Interconnected Alarms only - Test the first unit by pressing the button for 10 seconds. All the units should alarm within 10 seconds of the first horn sounding. The red light, on the first unit only, will flash about once a second. On releasing the button, the local Alarm will stop sounding immediately and the remote Alarms will stop sounding approximately 3 seconds later (if testing using RF interconnection this could take slightly longer). This feature gives an audible verification that the interconnection is OK. Check all the other Alarms in the same way.
- (vii) Check the functioning of the battery back-up directly after installation and then at least yearly as follows:
 - Turn off the mains power at the distribution board and check that the green LED is extinguished.
 - Press the test button and ensure the horn sounds loudly for 10 seconds.
 - Monitor the Alarm over a 3-minute period for any fault chirps and red LED fault indicator flashes (Refer to **Fault Mode** table on what to do if this occurs).
 - Turn the mains supply at the distribution board back on.

Switching off Mains for long periods

If the premises are regularly being left without mains power for long periods the Smoke/Heat Alarms should be removed from their mounting plates to prevent the batteries becoming fully depleted. (This is sometimes done with holiday homes which are only occupied in the Summer).

The Alarms must be re-attached to the mounting plates when the premises are re-occupied.

WARNING: DO NOT TEST WITH FLAME

This can set fire to the Alarm and damage the house.

We do not recommend testing with smoke or heat as the results can be misleading unless effective apparatus is used.

3.2 Changing the battery back up

NOTE: Constant exposure to high or low temperatures or high humidity may reduce the life of the battery.

1. Switch off mains power to Alarm (green light on cover should go out).
2. Remove unit as shown in “**ALARM REMOVAL**” section on page 16.
3. Locate battery slot in base of Alarm as shown below.

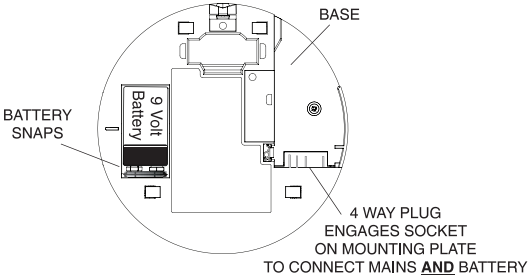

4. Unclip battery from battery snap connectors.
5. Connect new battery by clipping back on to battery snap connectors. Use only 9V Alkaline batteries Duracell MN1604, Energizer 522. Other batteries can cause problems.

We recommend that the “replace by date” on the battery should still have at least 2 years to go. Older batteries will give beeps prematurely.

6. Slide unit back on to the base. A click should be heard as the Alarm engages. (The unit cannot be replaced on the base unless a battery is installed).
7. Press and hold the test button - horn should sound loudly.

Reinstate mains power to Alarm (green light on cover should come on).

3.3 Cleaning your Alarm

Clean your Alarm regularly. In dusty areas it may be necessary to clean the Alarm more frequently.

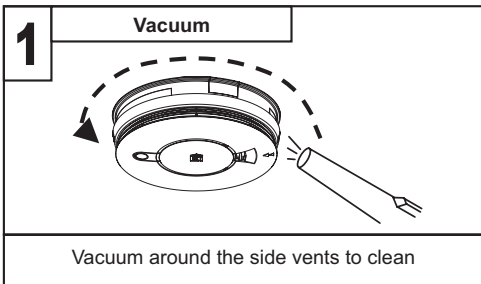

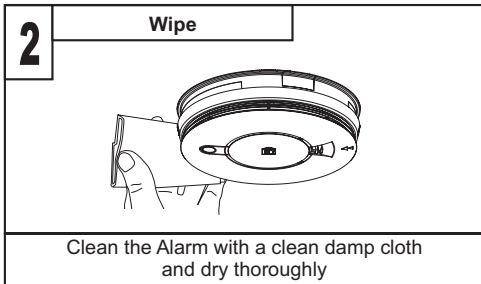

Use the narrow nozzle attachment of your vacuum cleaner to remove dust, insects and cobwebs from the sides and cover slots where the airflow enters. Clean the outside cover by occasionally wiping with a clean damp cloth then dry thoroughly with a lint free cloth. Do not use any cleaning agents, bleaches, detergents or polishes, including those in aerosol cans.

WARNING: Do not paint your Alarm.

Other than the cleaning and changing the battery back up described above, no other customer servicing of this product is required. Repairs, when needed, must be performed by the manufacturer.

All Alarms are prone to dust and insect ingress which can cause nuisance/false alarms or failure to alarm.

In certain circumstances even with regular cleaning, contamination can build up in the smoke sensing chamber causing the Alarm to sound or fail. Contamination is beyond our control, it is totally unpredictable and is considered normal wear and tear.

For this reason, contamination is not covered by the guarantee.

4. What to do in case of alarm

WARNING: If your Alarm sounds and you are unsure of the cause, it should be assumed that the alarm is due to an actual fire and the dwelling should be evacuated immediately.

1. Check room doors for heat or smoke. Do not open a hot door. Use an alternate escape route. Close doors behind you as you leave.

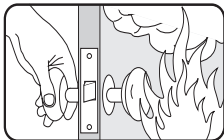

2. If smoke is heavy, crawl out, staying close to floor. Take short breaths, if possible, through a wet cloth or hold your breath. More people die from smoke inhalation than from flames.



3. Get out as fast as you can. Do not stop for packing. Have a prearranged meeting place outside for all family members. Check everybody is there.



4. Call the Fire Brigade immediately on a mobile phone or from a neighbour's house. Make sure to call the Brigade for all fires no matter how small - fires can suddenly spread. Also call the Brigade even if the alarm is automatically transmitted to a remote manned centre - the link may have failed.



















5. **NEVER** re-enter a burning house.













5. Indicators

5.1 Indicator summary tables





Normal mode				
Mode	Action	Green LED (power)	Red LED (alarm)	Sound
Power up	Slide onto mounting plate		 ¹ x 1	—
Standby	—		 every 40 sec x 1	—
Testing (Monthly)	Press and hold test/hush button		 every 0.5 sec x 1	
In alarm mode				
Detecting fire	—		 every 0.5 sec x 1	
Activated via interconnect	—		—	
Pressing Test/hush Button on Alarm detecting fire	—		 every 10 sec x 1	 x 10mins
Memory mode				
0-24h	—		 every 40 sec x 2	—

¹ If there is a fault, in addition to the Red LED flash, the Alarm will chirp once

 = AC power on  = LED flashing  = Alarm  = Chirp

Fault modes indicators				
What you hear / see			What it means	What to do
Green LED (power)	Red LED (alarm)	Chirps		
—	 every 40 sec x1	—	AC mains off	Reconnect AC mains power
	 x1 +  x1 every 40 sec	—	Low battery backup	Replace ¹ Battery
	 x1 Alternating every 20 sec	 x1	Sensor fault	Replace Alarm
	 every 40 sec x1	 x1 every 20 sec	Low battery backup + sensor fault	Replace Alarm

¹ If the replace by date on the label at the side of the Alarm has passed, replace the Alarm

Fault mode indicators when pressing test/hush button				
Fault	Action	Green LED (power)	Red LED (alarm)	Sound
Low battery Backup	On release of test/hush button		 x 1	 x 1
Faulty Sensor	Press and hold test/hush button		—	—

5.2 Troubleshooting

1. YOUR ALARM DOES NOT SOUND WHEN YOU PRESS THE TEST/HUSH BUTTON

- (1) Check the Alarm is secured on the mounting plate.
- (2) Wait 15 seconds after connecting the power before button testing.
- (3) Hold button down firmly for at least 10 seconds.
- (4) If the Alarm does not sound, then your Alarm must be returned for repair or replacement – see section 8.1 - **Getting your Alarm serviced.**

2. YOUR SMOKE ALARM SOUNDS FOR NO APPARENT REASON

- (1) If, after evacuating and observing the dwelling, there is no sign of smoke, heat or noise to indicate that there is a fire, check the house carefully in case there is a small fire smoldering somewhere.
- (2) Check for smoke, fumes, steam, very hot air etc.
- (3) Locate the Alarm that sounds and has a flashing red LED.
- (4) If you have thoroughly investigated and are sure that it is just a nuisance alarm, simply press the Test/Hush button briefly to silence the Alarm for 10 minutes. This will also silence any interconnected Alarms for the same period. When the Alarm is in “Hush” mode the red LED will continue to flash while it detects the presence of smoke or heat. The Alarm will reset to normal functionality at the end of the 10 minutes. If additional silenced time is required, simply push the Test/Hush button again.
- (5) If you experience frequent nuisance/false alarms, it may be necessary to re-locate the Alarm away from the source of the fumes or if it continues to sound without smoke or heat being present and cleaning the Alarm does not solve the problem, it needs to be replaced.

3. INTERCONNECTED ALARMS DO NOT ALL SOUND

- (1) Hold test/hush button for at least 10 seconds to ensure that the signal is transmitted to all the interconnected Alarms.
- (2) If this is not the case and you have a hardwired interconnection, we recommend you consult a qualified electrician.
- (3) If the Alarm is fitted with an RF mounting plate for wireless interconnection, check that all RF devices are powered and are house-coded correctly.

4. PRESSING THE TEST/HUSH BUTTON DOES NOT SILENCE THE ALARM

Always make sure that you are pressing the Test/Hush button on the Alarm that sounds with the red LED flashing.

5. YOUR ALARM CHIRPS/BEEPS/FLASHES

The Alarm automatically monitors the battery, sensor and electronics periodically to ensure that all are satisfactory. If a fault has been found, the Alarm alerts the occupier to this via short chirps and red LED flashes.

- (1) If the battery is depleted, the Alarm will chirp and flash the red LED at the same time once every 40 seconds. Replace the battery following the steps indicated in section 3.2 - **Changing the battery back up**.
- (2) If the Alarm has found a fault with the sensor / thermistor, it will chirp and flash the red LED but **NOT** at the same time. In this case, the Alarm must be returned for repair or replacement, see Section 8 - **Service and Guarantee**.
- (3) If both a low battery and a sensor/thermistor fault exist at the same time, the Alarm will alternate a chirp and flash of the red LED with a single chirp. In this case, the Alarm must be returned for repair or replacement, see section 8 - **Service and Guarantee**.

6. Important Safeguards

When a fire system is installed, basic safety precautions should always be followed, including those listed below:

- Please read all instructions.
- **IMPORTANT:** Experience has shown that children may not be woken by fire alarm tones. It is important that children are never left alone in a house. Families should have a fire escape plan that is rehearsed, so that everyone knows how to escape when fire occurs. The immediate priority when fire occurs is to ensure that any sleeping children are woken from sleep and are immediately taken to a place of safety outside the property, along with all other occupants. The fire and rescue service should always be called without delay, no matter how small the fire.
- Use the Testing of the Alarm as a means to familiarise your family with the alarm sound and to practice fire drills regularly with all family members. Rehearse emergency escape plans so everyone at home knows what to do in case the Alarm sounds. Further information can be obtained from your local fire prevention officer.
- To maintain sensitivity to Fire, do not paint or cover the Alarm in any manner and; do not allow cobwebs, dust or grease to accumulate.
- If the Alarm has been damaged in any way or does not function properly, do not attempt a repair. Return the Alarm - see section 8 - **Service and Guarantee**.
- This appliance is only intended for premises having a residential type environment.
- Fire Alarms are not a substitute for insurance. The supplier or manufacturer is not your insurer.
- Do not dispose of your Alarm in a fire.

7. Limitations of Fire Alarms

Smoke / Heat Alarms have significantly helped to reduce the number of fire fatalities in countries where they are widely installed.

However independent authorities have stated that these systems may be ineffective in some fire situations. There are a number of reasons for this:

- The Alarms will not work if the mains power supply is off or disconnected and the backup battery is depleted. Test regularly to ensure the power supply is functioning as required.
- The Alarms will not detect fire if sufficient heat/smoke does not reach the Alarms. Heat/smoke may be prevented from reaching the Alarm if the fire is too far away, for example, if the fire is on another floor, behind a closed door, in a chimney, in a wall cavity, or if the prevailing air drafts carry the heat/smoke away. Installing Heat Alarms and Smoke Alarms on both sides of closed doors and throughout the house or premises as recommended in this leaflet will significantly improve the probability of early detection.
- The Alarms may not be heard. An Alarm may not wake a person who has taken drugs or alcohol.
- The Alarms may not detect every type of fire to give sufficient early warning.
- The Alarms don't last indefinitely. The manufacturer recommends regular testing and replacement after, at most, 10 years, as a precaution.

8. Service and Guarantee

8.1 Getting your Alarm serviced

If, within the guarantee period, your Alarm fails to work after you have carefully read all the instructions, checked the unit has been installed correctly, and is receiving AC power (green LED on), then contact us.

If you are advised to return your Alarm, please ensure that the Alarm is placed in a padded box, not attached to the mounting plate (as the Alarm can give beeps or alarm if the Test/Hush button is pressed during shipping), with the proof of purchase and a note stating the nature of the fault.

8.2 Guarantee

Ei Electronics guarantees this Alarm for five years from the date of purchase against any defects that are due to faulty materials or workmanship. If this Alarm should become defective within the guarantee period, we shall at our discretion repair or replace the faulty unit.

This guarantee only applies to normal conditions of use and service, and does not include damage resulting from accident, neglect, misuse, unauthorised dismantling, or contamination howsoever caused. This guarantee excludes incidental and consequential damage.

This guarantee does not apply to any product that has been modified in any way by a third party or has been fitted with a third party element.

Do not interfere with the Alarm or attempt to tamper with it. This will invalidate the guarantee but more importantly may expose the user to shock or fire hazards.

This guarantee is in addition to your statutory rights as a consumer.

The crossed out wheellie bin symbol that is on your product indicates that this product should not be disposed of via the normal household waste stream. Proper disposal will prevent possible harm to the environment or to human health. When disposing of this product please separate it from other waste streams to ensure that it can be recycled in an environmentally sound manner. For more details on collection and proper disposal, please contact your local government office or the retailer where you purchased this product.



Ei Electronics, Shannon, Co. Clare, Ireland
21
DoP No.21-0002

EN14604:2005 + AC:2008

Smoke Alarm Devices:
Ei146e

Fire Safety

Nominal activation conditions/ sensitivity, response delay (response time) and performance under fire condition	Pass
Operational reliability	Pass
Tolerance to voltage supply	Pass
Response delay and temperature resistance	Pass
Vibration resistance	Pass
Humidity resistance	Pass
Corrosion resistance	Pass
Electrical stability	Pass



Heat Alarm Devices:
Ei144e

The Declaration of Performance No. 21-0002 may be consulted at www.eielectronics.com/compliance

**UK
CA**
0086

Ei Electronics, Shannon, Co. Clare, Ireland
21
DoP No.21-0002

EN14604:2005 + AC:2008

Smoke Alarm Devices:
Ei146e

Fire Safety

Nominal activation conditions/ sensitivity, response delay (response time) and performance under fire condition	Pass
Operational reliability	Pass
Tolerance to voltage supply	Pass
Response delay and temperature resistance	Pass
Vibration resistance	Pass
Humidity resistance	Pass
Corrosion resistance	Pass
Electrical stability	Pass

**UK
CA**

Heat Alarm Devices:
Ei144e

The Declaration of Performance No. 21-0002 may be consulted at www.eielectronics.com/compliance

Contact Us

Aico Ltd

Mile End Business Park, Maesbury Rd, Oswestry,
Shropshire SY10 8NR, U.K.

Tel: 01691 664100

www.aico.co.uk

Ei Electronics

Shannon, V14 H020, Co Clare, Ireland.

Tel: 061 471277

www.eielectronics.com